

DVK Harben Van Pack

- Suitable for drains up to 300mm
- Manual or 7 channel Radio
- Emission compliant diesel engine
- Proven Harben® reliability
- Long range cleaning ability
- Unique Run Dry pump

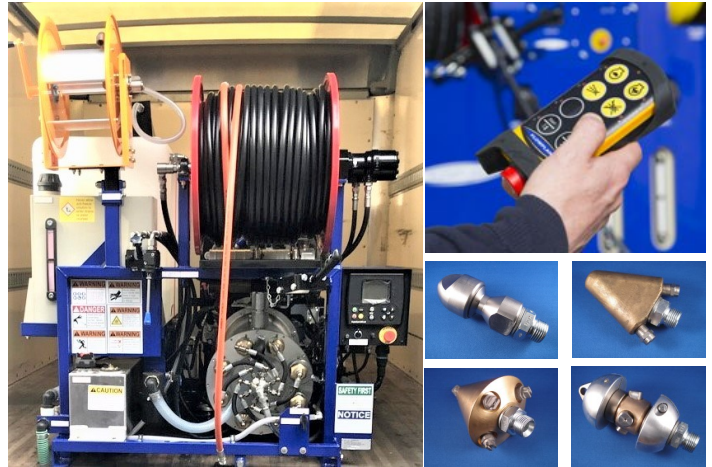

Model	DVK Van Pack
Pressure and Flow	Up to 275 bar / Up to 55 litres per minute (4000 psi / 12 gpm) Up to 350 bar / Up to 41 litres per minute (5000 psi / 9 gpm) Up to 415 bar / Up to 32 litres per minute (6000 psi / 7 gpm)
Pump	Harben® 'P' type radial piston diaphragm
Engine	Stage 5 emission compliant water cooled diesel
Water Tank	Single - 400 litres (90 gallons) Twin - 800 litres (180 gallons)
Frame	Lightweight folded steel shot blasted and powder coated
Hose Reel	Variable-speed hydraulic-rewind hose reel with 100m high-pressure hose capacity
Dimensions	1800 mm long x 1400 mm wide x 1520 mm high *
Weight	Dry weight from 765kg dry or 1135kg full *
Suggested Accessories	- 1/2" Standard jetting hose - 90m (300ft) - 3 x 1/2" Standard drain jets (3r, 3r1f & 6r) - 1/2" Safety leader hose - 3m (10ft) - 1/2" Drain jet extension - 9" - Inlet hose reel

* All weights and dimensions are approximate

Flowplant Group Ltd

Gemini House, Brunel Road,
Churchfields Industrial Estate,
Salisbury, Wiltshire. SP2 7PU
United Kingdom

t: +44 (0)1722 325 424
f: +44 (0)1722 411 329
e: sales@flowplant.com

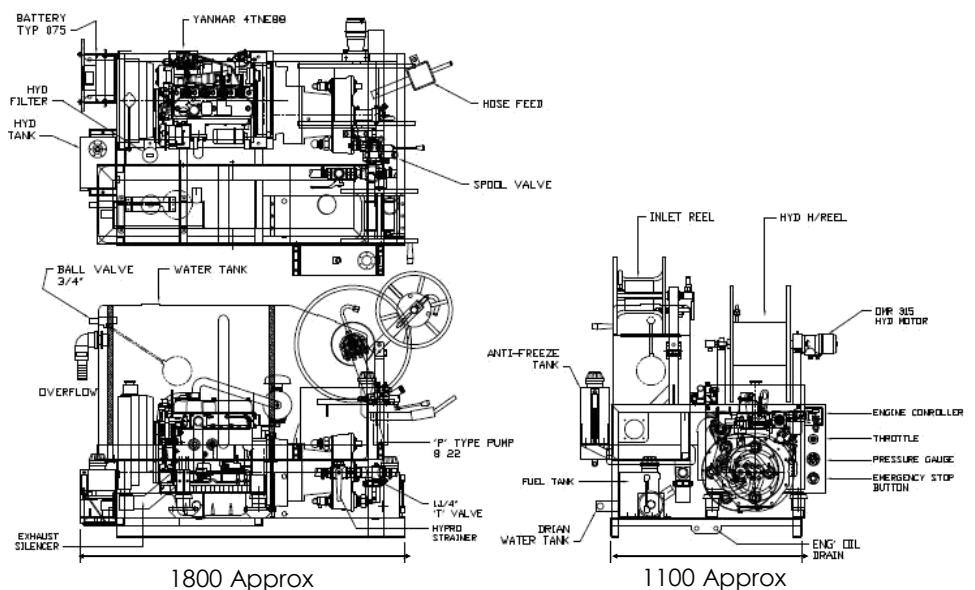

- High Pressure
- Cleaner Solutions





Flowplant Group Ltd provides the information herein in good faith but makes no representation as to its comprehensiveness or accuracy. This data sheet is intended only as a guide to Flowplant Group Ltd products and services. Individuals using this data sheet must exercise their independent judgment in evaluating product selection and determining product appropriateness for their particular purpose and system requirements. Flowplant Group Ltd MAKES NO REPRESENTATIONS OR WARRANTIES, EITHER EXPRESS OR IMPLIED, INCLUDING WITHOUT LIMITATION ANY WARRANTIES OF MERCHANTABILITY OR FITNESS FOR A PARTICULAR PURPOSE WITH RESPECT TO THE INFORMATION SET FORTH HEREIN OR THE PRODUCT(S) TO WHICH THE INFORMATION REFERS. ACCORDINGLY, Flowplant Group Ltd WILL NOT BE RESPONSIBLE FOR DAMAGES (OF ANY KIND OR NATURE, INCLUDING INCIDENTAL, INDIRECT, OR CONSEQUENTIAL DAMAGES) RESULTING FROM THE USE OF OR RELIANCE UPON THIS INFORMATION. Flowplant Group Ltd reserves the right to change product designs and specifications without notice.

Accessories can be viewed in our Drain Cleaning Accessories catalogue or online at <http://www.flowplant.com/drain-jetters/accessories/>

	Nozzles	Part No.
	1/2" Standard Drain Jet - 3r 1/2" Standard Drain Jet - 3r,1f 1/2" Standard Drain Jet - 4r 1/2" Standard Drain Jet - 4r,1f 1/2" Standard Drain Jet - 6r 1/2" Standard Drain Jet - 6r,1f	056097 056413 056582 056583 056584 056585
	1/2" High Efficiency Jet - 3r 1/2" High Efficiency Jet - 3r,1f 1/2" High Efficiency Jet - 4r 1/2" High Efficiency Jet - 6r	056670 056671 056672 060133
	1/2" High Efficiency Sapphire Jet (3r, 3r1f, 6r or 6r1f)	0561126
	Mini Jet (Ball) - 3r Mini Jet (Ball) - 3r,1f	056126 056412
	1/2" Plough Jet - 2r	056044
	1/2" Rocket Jet - 4r	056845
	Turbo Jet - 2r	056323
	1/2" Chain Flail	056982
	Root Cutter Saw Set with Motor Root Cutter Blade - 100mm Root Cutter Blade - 150mm Root Cutter Blade - 225mm	056981 056989 056967 056968
	WH 1/2 Warthog Descaling Jet	056707
	1/2" Aquaspin - 3 fixed, 4@45° 1/2" Aquaspin - 3 fixed, 4@90°	056645 056653
	High Efficiency Sapphire Silt Bomb (3r, 3r1f, 6r or 6r1f)	0561127

	Jetter Options	Part No.
	Radio Remote Control	004427
	Jump Jet Kit	057041

	Jetting Accessories	Part No.
	Mini Jet Kit - 6m - 3r1f Mini Jet Kit - 6m - 3r Mini Jet Kit - 15m - 3r Micro Mini Jet Kit - 6m - 3r1f	023220 023227 023275 032601
	Tiger Tail - 2" Tiger Tail - 3"	0551443 055147
	Drain Jet Extension - 9" Drain Jet Extension - 12" Drain Jet Extension - 18"	033085 033086 033087
	Foot Control Valve	031043
	MkII High Pressure Dump Gun Shoulder Stock MkII Gun Safety Shroud P&A Gun Spinning Nozzle - 2f	031040 7001931 7001679 056326
	2" Jet Pump - Output 70gpm 2" Jet Pump - Output 55gpm	039001 039001
	Hoverclean - 0.7m Cleaning Width	023228

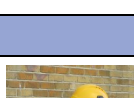
	Hoses	Part No
	Tuffskin Lightweight Hose - 90m	0551229
	Stauffshield Hose - 90m Stauffshield Hose - 30m	0551580 0551623
	Safety Leader Hose - 3m	055093

	Safety Equipment	Part No.
	Jetting Helmet Set	065013
	Jetting Safety Boots (Sizes 6 - 12)	TBC
	Waterproof Suit (Sizes S - XL)	TBC
	Gauntlet Gloves	065064
	Safety Burst Discs (White 4000psi)	011046
	Safety Burst Discs (Black 5000psi)	011047
Safety Burst Discs (Orange 6000psi)	011107	
	Safety Sign	061054